

Ages 10 to adult

Thief's Player Pack



The BEGINNER'S GUIDE to the



Thief



Advanced Dungeons & Dragons[®]

2nd Edition Game Accessory

The Beginner's Guide to the Thief

Design: William W. Connors
Editing: John D. Rateliff
Coordination: Bruce Nesmith
Interior Art: Terry Dykstra
Photography: Charles Kohl
Models: Dennis Kauth
Production: Nancy J. Kerkstra

This material is protected under the copyright laws of the United States of America. Any unauthorized use of the material or artwork contained herein is expressly prohibited without the written consent of TSR, Inc. Copyright ©1994 TSR, Inc. All Rights Reserved. Printed in the U.S.A.

Random House and its affiliate companies have worldwide distribution rights in the book trade for English language products of TSR, Inc. Distributed to the book and hobby trade in the United Kingdom by TSR Ltd. Distributed to the toy and hobby trade by regional distributors.

ADVANCED DUNGEONS & DRAGONS and AD&D are registered trademarks owned by TSR, Inc.
The TSR logo is a trademark owned by TSR, Inc.
All TSR characters, character names, and the distinctive likenesses thereof are trademarks owned by TSR, Inc.

TSR, Inc.
PO Box 756
Lake Geneva
WI 53147
U.S.A.



TSR Ltd.
120 Church End
Cherry Hinton
Cambridge CB1 3LB
United Kingdom

1115XXX1901

ISBN 0-7869-0042-3

The Making of a Thief

Thieves can be one of the most entertaining character classes in the AD&D® game. In order to have the greatest possible fun running such a character, however, it is wise to think about a few points during the process of initial character generation.

Initial Concept: No other character class offers a player the potential diversity of skills and abilities that the thief class does. With just a little bit of work, a player can design anything from a deadly assassin to the most skillful cat burglar in the city.

In some cases, Dungeon Masters may have suggestions (or even requirements) about what type of thieves will fit best in the campaign. A back-alley thug, for example, would hardly be appropriate to a campaign in which the characters hobnob with royalty in the palace on a regular basis. Any player planning to run a particularly unusual type of thief should be certain to clear it with the DM before starting the character-generation process.

Ability Scores: The most important ability score for any thief character is Dexterity; a high score here entitles the character to an experience point bonus and provides him or her with bonuses in the various thief abilities. But it is the other attribute scores which will individualize the character. A thief with high Strength and Constitution scores may be a combat-oriented mugger or Guild enforcer, while one with good personality attributes (Intelligence, Wisdom, Charisma) might make a good confidence man.

Thief Abilities: The way in which a player allocates points to his or her character's thieving abilities goes a long way toward defining that character. A sneak thief might allocate the majority of his or her points to the Hide in Shadows and Move Silently abilities, while another thief might specialize in Pick Pockets



or Open Locks.

Proficiencies: In addition to the various thief abilities, a player can further customize his or her character by careful selection of proficiencies. A spy will be well served by skills such as disguise or lip reading, while a fence will no doubt want to master appraising (to identify the best loot) or gem cutting (to dispose of the goods).

In addition to the obvious skills suggested by the player's vision of his or her character, it's always a good idea to select one or two out-of-the-ordinary

proficiencies that will give the character a distinctive personality. For example, imagine a cat burglar who selects the animal training proficiency and thereafter sends her trained ferret into a target's house first to make sure no one is home. Such a character would be all the more interesting to play if the thief thinks of himself or herself as a nocturnal creature as well.

Weapons, Armor, & Equipment: A character can be further defined by the equipment he or she carries. A pickpocket will usually avoid wearing any armor, in order not to attract attention, while an adventuring scout is not likely to be found without it. A burglar will typically carry some small, easily concealed weapon, while a robber will brandish a large, intimidating one. A player should always select equipment that fits the distinctive personality and expertise of his or her character.

For the most part, thieves of any type will want to travel light, depending upon their wits and agility to escape danger. The special equipment of their class, lock picks and the like, weigh next to nothing. Any player should think twice before making his or her thief carry too much equipment—after all, it cuts down on the amount of loot he or she can make off with!

Tricks of the Trade

Once a player has created his or her thief character, the challenge really begins. Because of the special abilities and disadvantages of the thief class, players running thief characters will want to keep a number of important points in mind during play.

Combat: While thieves are no match for fighters in head-to-head combat, they are deadly when attacking from ambush. Depending upon the type of thief that a player is running, the types of attack that he or she employs will vary. Surprise, however, will always be an important element. An assassin or ninja-like character will often spring from the shadows to strike with a small weapon such as a knife or garotte. A thief acting as a scout might strike from cover with a short bow or poisoned dart. Most thieves will in time develop a "signature style" to let others know he or she is responsible for a particular crime, thus enhancing the character's reputation.

Leading the Way: One of the most common roles assigned to the average thief in an adventuring party is that of the scout. *This is not unreasonable.* Because most thieves can move quietly and avoid being seen, they are often able to spot an enemy, trap, or other hazard before it can pose a threat to the rest of the party.

Of course, there are great dangers associated with this role. If the thief fails to notice a trap, he or she may fall subject to its effects. In many cases, a trap that would only injure a rugged fighter will inflict enough damage to kill a thief. Similarly, there is always the danger that the thief will stumble upon a monster that is too much for him or her to handle. After all, even the best thief doesn't always manage to surprise the enemies he or she encounters.

When acting as a scout, the player must be



certain not to expose his or her character to any unnecessary risks and should avoid combat whenever possible. Frequent use of the Find and Remove Traps, Move Silently, and Hide in Shadows abilities will do wonders for the character's life expectancy.

Breaking & Entering: Of course, one of the things that a thief does best is steal. This could mean cutting a wealthy merchant's purse, cracking the lock of a stout safe, or simply waylaying a few sailors.

Most adventuring parties, however, don't depend upon

the thief in the party to raise money. After all, knocking a few ogres on the head is hardly a good way to accumulate a steady supply of gold. This does not mean that the skills of a burglar or pickpocket will be wasted in their company.

Instead of targeting loot, the thief often turns his or her talents toward the party's special needs. Perhaps an important document has been hidden away in the library of the local Burgomaster. While the party attend a formal dinner at the Burgomaster's, the thief slips away from the company, makes his or her way to the safe, and extracts the document.

With a little thought, the player can find countless ways for a thief character to use his or her talents. For example, as the local sheriff throws the party into a jail cell, the thief might bump against her and lift the spare key out of her pocket. When a party is faced with a pit too wide to jump, their thief can scale the walls to the other side, set a spike, and create a rope bridge for his or her companions to cross.

Of course, none of these actions (or the others that will present themselves to an alert player) is free of danger. The slightest mistake, and the thief may be rewarded only with a quick death. But as they say, if it's easy, it's not worth doing.

Song, Stories, & Showmanship

Closely related to the thief is the bard; in fact, both are part of the larger rogue class. Masters of song, story, and showmanship, bards enjoy life to its fullest, looking upon each adventure as nothing more than inspiration for their next great tale.

As a class, bards are able to employ many of the abilities normally associated with thieves. In addition, they can cast a few spells, hold their own in a fight, and serve as great sources of information or morale building.

With so many talents and abilities, bards are a difficult class to play. With that in mind, here are a few tips that novice and veteran players alike should keep in mind when running a bard.

Role-Playing: Bards are, first and foremost, entertainers. They love nothing more than a good tale by a campfire, an exchange of wit in the local pub, or a reading of romantic poetry before the royal court.

Each bard has a favorite type of performance. Some might be primarily singers or instrumentalists, others mainly actors, and some acrobats or jesters. The more individualized the character, the better the player and others in the group can form a mental image of him or her.

This can easily be done with proficiencies. An unusually agile bard with the juggling skill may well build his or her whole routine around that technique, allocating additional proficiency slots to it, while having no great interest in playing a musical instrument.

This is a good start, but there is still more to be done. Just as no two swordsmen or archers employ exactly the same techniques, no two singers or comedians will use identical routines to win the favor of an audience. To that end, each player should develop a shtick or identifying style for his or her character to



stand out.

Remember our example of the juggler? This description of the character is all well and good, but jugglers are, as they say, a silver piece a dozen. Now, if the bard juggles only things like razor-sharp throwing axes, burning torches, or acrobatic mice, his or her routine (and hence the whole character) becomes much more memorable.

Been There, Done That: As noted in the *Player's Handbook*, bards tend to accumulate a lot of unusual knowledge in the course of their travels

(nobody gossips like a bard). This is reflected in the basic chance that a bard has to identify magical items and the like.

A careful player will make liberal use of this talent during game play, knowing that a good DM will have made notes of the lore associated with many of the important people, places, and things in his or her campaign. This information can then be used to provide the players with the clues that they need to successfully resolve an adventure.

By the same token, any bard worth his or her salt should show an interest in everything that transpires around him or her. This is especially true of things like old myths or legends, superstitions or religious beliefs, and the chance to visit famous place or meet renowned individuals. Bards are insatiably curious people. So what if the Radiant Canyon is one of the most dangerous places in the world? It's also one of the most beautiful, and many poets have written magnificent verses about it, making it well worth risking a visit!

Above all, bards never outgrow the love of learning, the thrill of adventure, and the appreciation of beauty. Endlessly optimistic, they feel that the harder the adventure, the better the story it will make afterwards!

The Character Record Sheet

Included with the *Thief's Player Pack* is a tablet of 12 character record sheets (often just called character sheets). These provide a simple way for players to keep track of the important information that defines their characters. TSR grants permission to photocopy these sheets for personal use.

These sheets are designed to be easy to use. All of the information on the sheet is grouped into the following blocks for easy reference.

1. Personal Information: In this area the player can record the name he or she makes up for the character, as well as information about the character's race, class, level, and alignment. Additional spaces permit the player to record a general description of his or her character.

2. Ability Scores: This is probably the first area of the character sheet that the player will fill out when creating a new character. It includes spaces for keeping track of a character's ability scores and all of the game modifiers generated by them.

3. Hit Point Record: This portion of the character record sheet is placed where it will be easy to see and use at all times. A character's current hit point total is likely to change frequently during combat, so players should write lightly when recording information on wounds their characters receive.

4. Attack Table: This part of the character record sheet will probably be referenced more often than any other. There is a space to record the character's THAC0 listing as well as the melee and missile attack modifiers determined by the character's Strength and Dexterity scores.

Once these three boxes at the top are filled in, the player can quickly fill out the table of rolls required to hit various Armor Classes from 10 to -10. It is recommended that no

modifiers be applied when recording the numbers in this column; instead, players should write in the basic roll needed to hit a target of the Armor Class listed.

5. Weaponry Information: In this space the player can record the specifics on the character's favorite weapons, along with the attack penalty the character suffers when using a weapon with which he or she is not skilled. The information is grouped by general notes, attack data, and damage specifications.

6. Armor Class Information: In this block the player can record the type of armor his or her character is wearing, if any, and the effect it has on his or her Armor Class. Space is provided to record the Armor Class the character has when surprised, caught without a shield (if he or she uses one), or attacked from behind. Additional information on bonuses due to Dexterity or magical protection can be recorded in the Other Defenses box.

7. Character Sketch: Artistic players will want to draw a sketch of their character in this box. Others can select one of the portrait stickers included in this kit (or some other piece of artwork) and secure it here to help them visualize their character.

8. Experience Point Record: This space can be used to record the number of experience points (XPs) that the character has accumulated, along with the total needed to advance to the next level. The player can also note here whether his or her character is entitled to the 10% bonus in XPs awarded to characters with exceptional scores in the prime requisite of their chosen class.

9. Saving Throw Table: In this space the player can record all of the saving throws appropriate to the character due to his or her class and level.

The Character Record Sheet

10. Class Abilities: This area can be used to record important information about the special talents a character has due to his or her class. Thief characters, for example, can record their special abilities and the extra damage they do with a backstabbing attack; bards their spells and Legend Lore and morale-boosting abilities.

11. Racial Abilities: Any special abilities a character has due to his or her race (such as infravision or silent movement) can be recorded here.

12. Weapon Proficiencies: Players in campaigns that use the optional weapon proficiencies rules should write down those weapons with which their character is skilled. Space is also provided to record the number of slots the character begins the campaign with, as well as the rate at which he or she accrues additional slots. The penalty for using a weapon with which the character is not proficient can be recorded here as well.

13. Nonweapon Proficiencies: Like Block 12, this area is intended for use by those campaigns employing the optional proficiency rules. The number of slots that a character begins with, the number of bonus slots he or she receives for high Intelligence (see the **add'l languages** box in Block 2), and the rate at which he or she acquires new slots can be recorded at the top of the box. The name of each skill selected by a player, the number of slots allocated to it, its relevant ability score, and any needed modifiers to proficiency checks can be recorded on the lines below.

14. Equipment Carried: This block can be used to record all of the equipment that a character takes along on an adventure, as well as the cost and weight of each item. A space at the bottom of the block allows the player to total the value and weight of the items he or

she is carrying. The former is mainly for record-keeping purposes, while the latter is used in conjunction with the rules on movement and encumbrance (Blocks 16 and 17).

15. Wealth: As a character adventures, he or she will gradually accumulate a great deal of wealth. This block allows a player to record the extent of his or her character's treasure. Separate columns are provided to list each different type of coin (cp, sp, gp, &c.), how much coinage is carried by the character when he or she goes on

an adventure, and how much he or she has hidden away in caches. A box at the bottom of the block provides space for the recording of unusual valuable items like gemstones or pieces of jewelry.

16. Encumbrance: For players in campaigns using the optional encumbrance rules, this space records the carrying capacity of a character (as indicated by his or her Strength score). In addition, notes remind the player of the negative effects that encumbrance will have on the character's combat abilities.

17. Movement: This block contains an easy-to-use table that the player can quickly fill out for reference during play. First, the base movement rate for the character (12 for humans, elves, and half-elves; 6 for dwarves, halflings, and gnomes) is recorded in the heavier block. The first column, which reflects the movement rate of a walking character at the various levels of encumbrance, can then be calculated quickly. Once this is done, the player can determine the rates of movement when his or her character is jogging or running by simply multiplying row by row. Thus, for humans the numbers in the first column will be 12, 8, 6, 4, and 1, while the numbers in the top row will be 12, 24, 36, 48, and 60.

The Mapping Tablet

One of the most useful things included with the Player Pack is a pad of mapping paper. A close look at this tablet will reveal that there are actually **four** types of paper in it. Each of these has a special use and allows the player to keep careful track of his or her character's various adventures. Care has been taken to make the papers in this tablet useful to both players and Dungeon Masters. In addition, TSR grants permission for AD&D game players to photocopy these sheets for personal use, so you'll never run out of them. Just make sure that you don't use your last original, or you won't have a good master left to copy.

A quick look at these sheets will reveal that the grids on them are not composed of solid lines. Rather, a pattern of crosses (or triads for the hex grids) is used. This is because a map drawn on a standard sheet of graph or hex paper is difficult to reproduce on a photocopier; the solid lines printed on the paper tend to make the hand-drawn map difficult to read. By contrast, photocopies of maps made on these sheets should be just as readable as the originals.

- **Regional Maps (½-inch hexes):** The regional map sheet is covered with a hexagonal grid. These sheets should be used for mapping large geographical areas, like a country. It can be used by players to map unexplored territory as their characters move through it or to lay out a plan of the grounds surrounding a player character's castle. The scales used on these maps will vary with the size of the territory being mapped.
- **Strategic Maps (¼-inch squares):** The next type of paper in the mapping tablet is a simple square grid. It is intended for use in

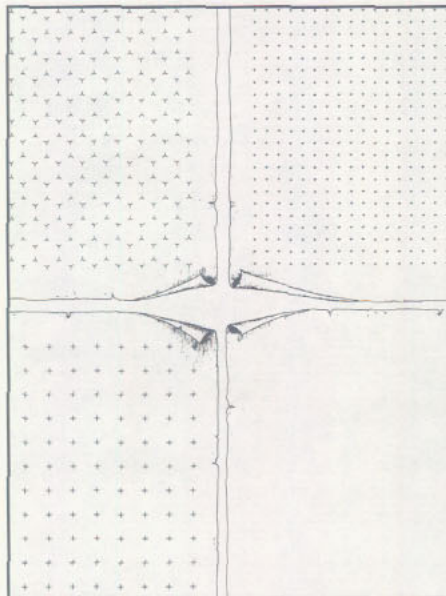

creating a strategic map of a large structure, such as the dungeon complex beneath a castle. Once a hexagonal regional map has been made of an area, the buildings on (or under) it can be mapped with this type of paper. This is the type of paper that players will generally use when mapping the dungeons their characters are exploring. In addition, when a character designs and builds a castle, temple, tower, or other large structure, the player can map it with these sheets.

- **Tactical Maps (½-inch squares):** This paper is intended for use in making maps of smaller areas, usually a close-up shot of some area on a strategic map. Players can use it to make more detailed maps of unusual rooms (tombs, shrines, and the like) that their characters encounter while exploring the dungeons recorded on the strategic maps. Once a player has mapped his or her character's stronghold, he or she can detail the most important areas of it on a tactical map.
The larger size of this grid makes it easy to use with metal miniatures as well. Players who decide to become Dungeon Masters will find these sheets useful for making maps of the rooms in a dungeon where combat is likely to take place. When the characters reach that area, just pull out the map of the area, place it on the table, and let the battle begin!
- **Parchment Blanks:** The last type of paper included in the kit is simply a blank sheet with a border on it that looks like curling parchment. This is intended primarily for those wishing to make props for use during game play. Players and Dungeon Masters can use this to create wanted posters, public notices recruiting followers, crude treasure maps, and similar documents.

Painting Guide

Many gamers find that their role-playing sessions are greatly enhanced by the use of miniature figures. While it is true that a whole book could be written on the many techniques involved in painting figures, the basics can be explained fairly briefly. Remember, though: the best way to become a skilled miniatures painter is to practice.

1. Cleaning: Even the best miniatures will need to be cleaned before they are ready to paint. Start by trimming away any excess metal and carefully filing away obvious seams, especially on the underside of the figure's base. After that is done, the figure should stand steadily on its own.

Once the miniature has been trimmed and smoothed, wash it in warm, soapy water to remove any dirt, grease, or oil. Set the figure out to dry, preferably overnight. After you have cleaned your figures, try to handle them as little as possible.

2. Mounting: It is always best to secure a figure to a base. For human-sized figures, it is customary to use a ½-inch square of poster board. In most cases, epoxy or super-strength glues work best. Of course, always use fast-bonding adhesives with care.

3. Priming: It is best to apply an undercoat, or primer, to your miniatures before painting them. The best all-around primer for miniatures is light gray in color and applied with a spray can. It is best to use a few thin coats of primer rather than a single thicker layer. After you prime your figures, let them dry overnight.

4. Base Colors: After your primed figures are fully dried, it is time to start painting them. It is usually best to start by painting the areas that



are hardest to get at. Another important thing to paint early on are areas of exposed flesh.

For more realistic figures, paint in the shadows in folds of clothing first, using a darker shade that complements the color you have chosen. After that dries, paint the rest of the item with the main color. Now, your figure will have lifelike folds and shadows.

5. Highlighting: When all of your base colors have dried, you can move on to highlighting. Start with a lighter color than the area you plan to high-

light. For example, when doing the highlights on a gray cloak, you could use a light gray or maybe even white. After you put the paint on your brush, dab it off with a piece of paper. Be careful not to crush the bristles, but make sure that there is no visible liquid left on the brush. Once that is done, lightly brush the color onto the area you want to highlight.

If you do it right, highlighting will leave you with light traces of paint on the raised areas of the figure.

6. Detailing: After all of your highlights are dry, go back and paint the little details. Now is the time to get the buttons on jackets, rivets on shields, and the like. When all is said and done, the highlights can make an otherwise average figure look outstanding!

7. Protection: When you are done painting your miniature, set it aside and let it dry overnight. Then apply a clear acrylic spray to your miniature to protect it from nicks, scratches, and dirt. Acrylic sealers come in both matte (dull) or gloss (shiny) finishes. Most people use a matte finish to make their figure look as realistic as possible. Use several thin coats of acrylic rather than one heavy one.



Male
Thief



Bard



Female
Thief



Character Name		Class (Kit)	
Alignment	Race	Experience Level	
Age & Sex	Height & Weight	Hair & Eyes	

Distinguishing Features

Strength		Melee Attack	Melee Damage	Weight Allowance	Max. Press	Open Doors	Bend /Lift
Dexterity		Surprise Adjust.	Missile Attack	Defensive Adjust.			
Constitution		Hit Point Adjust.	System Shock	Resurrect. Survival	Poison Save	Regen. Rate	
Intelligence		Add'l. Languages	Max. Spell Level	% Learn Spells	Max. No. /Level	Spell Immunity	
Wisdom		Magical Defense	Bonus Spells		% Spell Failure	Spell Immunity	
Charisma		Max. No. Henchmen	Loyalty Adjust.	Reaction Adjust.			

Weaponry Information Nonproficiency Penalty

Weapon Type	Type	Speed	# Attacks	Attack Adjust.	Ranges (S/M/L)	Damage Adjust.	Damage vs. S/M	Damage vs. L

Character Sketch

Experience Points

+10% XP Bonus? Yes No

Next Level XP Goal

Hit Points

Wounds Suffered

Attack Table

Melee Attack	THAC0	Missile Attack
-1		1
-2		2
-3		3
-4		4
-5		5
-6		6
-7		7
-8		8
-9		9
-10		10

Roll number or higher on 1d20

Armor Class

Armor Worn

Base AC	Surprised AC
Shieldless AC	Rear AC

Other Defenses

Saving Throws

Paralysis, Poison, or Death	Rod, Staff, or Wand	Petrification or Polymorph	Breath Weapon	Magical Spell
<input type="text"/>	<input type="text"/>	<input type="text"/>	<input type="text"/>	<input type="text"/>

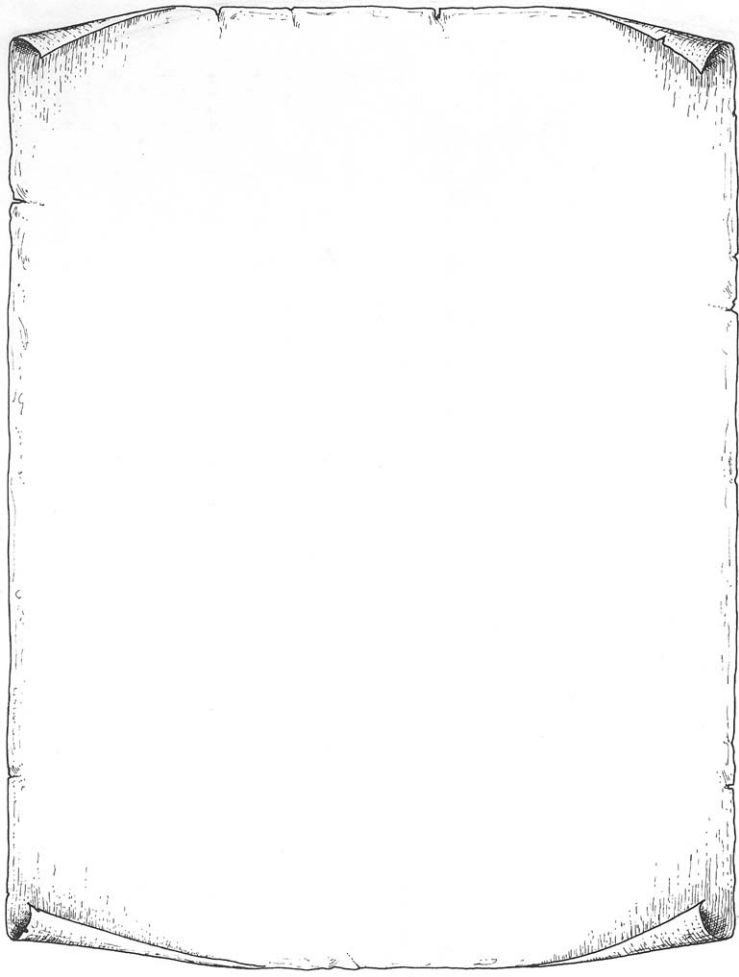

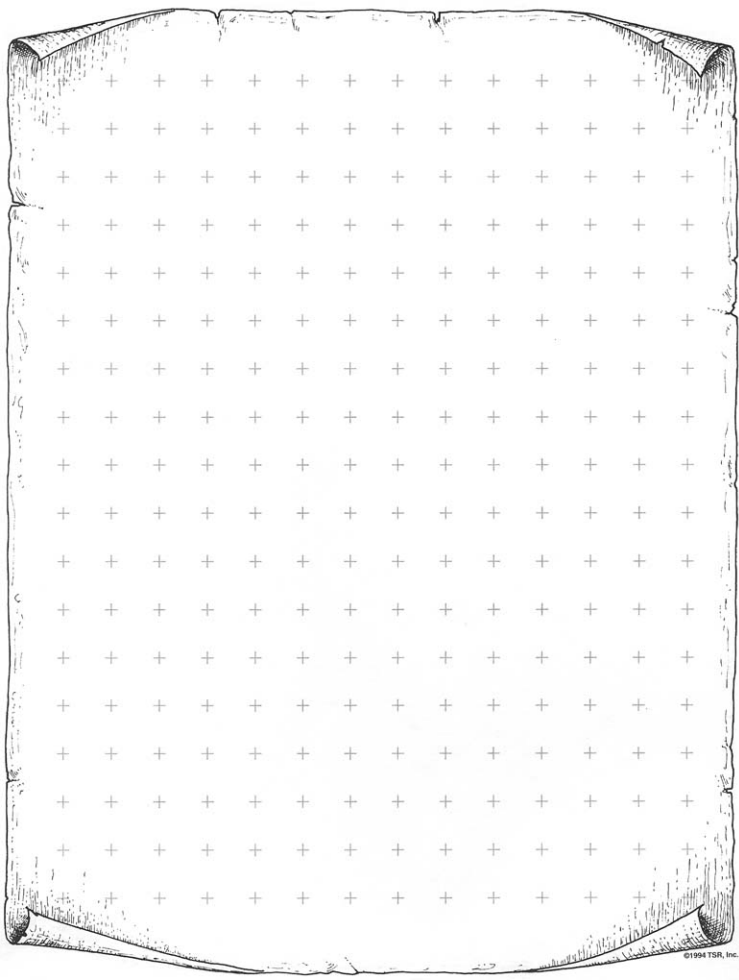

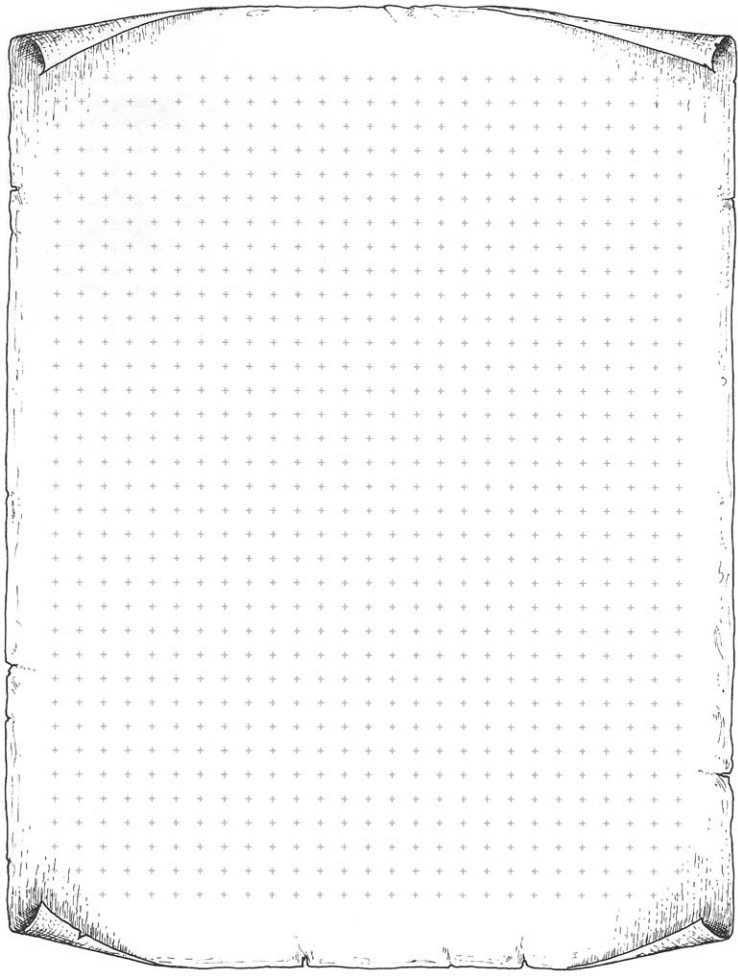

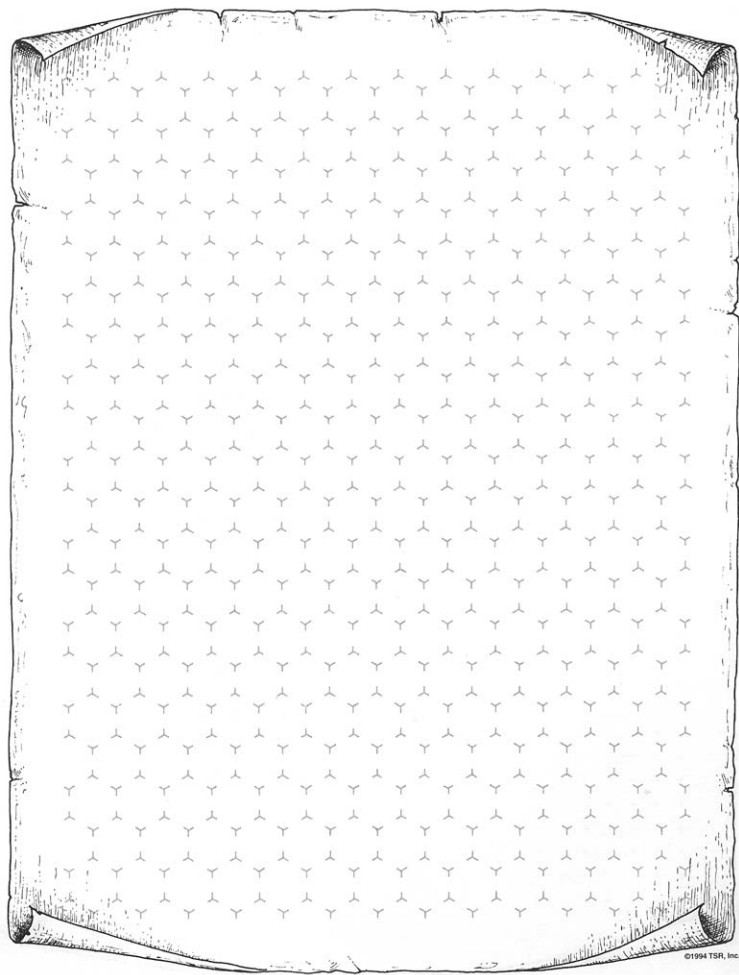

JOIN THE ADVENTURE!

ENTER NEW WORLDS OF EXCITEMENT AND FUN
IN EVERY ISSUE!

Dragon[®]
MAGAZINE

Dungeon[®]
ADVENTURES FOR TSR ROLE-PLAYING GAMES

The leader of the role-playing world offers gaming advice, new ideas, reviews, monsters, cartoons, and treasures not found anywhere else!

The module magazine for AD&D[®] and D&D[®] game players leads you to the limits of the known gaming universe!

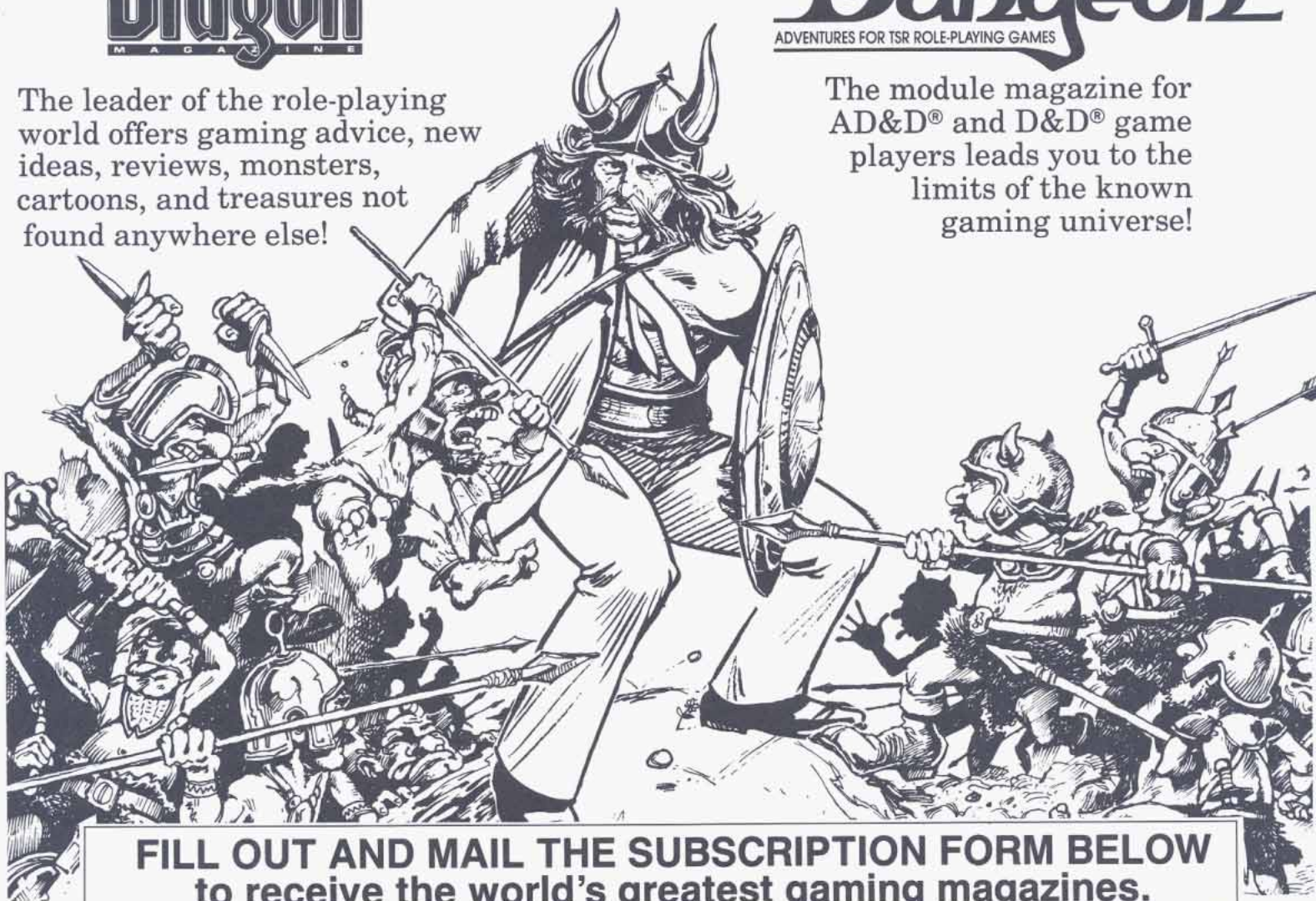

**FILL OUT AND MAIL THE SUBSCRIPTION FORM BELOW
to receive the world's greatest gaming magazines.**

DRAGON[®] Magazine

Subscription type:

- New Renewal (enclose mailing label)

Amount of payment (send U.S. funds only!)

- | | |
|---|---|
| To U.S. address | To Canadian address |
| <input type="checkbox"/> 1 year (12 issues) for \$30 | <input type="checkbox"/> 1 year (12 issues) for \$36 |
| <input type="checkbox"/> 2 years (24 issues) for \$57 | <input type="checkbox"/> 2 years (24 issues) for \$62 |
| <input type="checkbox"/> 3 years (36 issues) for \$84 | <input type="checkbox"/> 3 years (36 issues) for \$89 |

To foreign address

- 1 year (12 issues), by surface mail, for \$50
 1 year (12 issues), by air mail, for \$90

DUNGEON[®] Adventures

Subscription type:

- New Renewal (enclose mailing label)

Amount of payment (send U.S. funds only!)

- | | |
|---|---|
| To U.S. address | To Canadian address |
| <input type="checkbox"/> 1 year (6 issues) for \$18 | <input type="checkbox"/> 1 year (6 issues) for \$23 |
| <input type="checkbox"/> 2 years (12 issues) for \$33 | <input type="checkbox"/> 2 years (12 issues) for \$38 |
| <input type="checkbox"/> 3 years (18 issues) for \$48 | <input type="checkbox"/> 3 years (18 issues) for \$53 |

To foreign address

- 1 year (6 issues), by surface mail, for \$35
 1 year (6 issues), by air mail, for \$52

Check the appropriate boxes under the publication(s) to which you are subscribing. Then, mail this form with payments to: TSR, Inc., P.O. Box 5695, Boston MA 02206. (All payments must be in U.S. funds.)

(Please PRINT clearly.)

Name _____
Address _____
City _____ State/Prov. _____
Country _____ Zip/Postal Code _____

Method of Payment

- Check Money order MasterCard VISA

Credit card no. _____
Expiration date _____ MC bank no. _____
Signature _____ Date _____

Your first issue should arrive within 8 to 10 weeks in the U.S. and Canada. All prices are subject to change without notice.

(ASB)

Level	XP	Thief/Bard	Thief/Bard	Base+60	Base+20	Thief	Bard	Spells per Day	Weapon Prof.	Nonweapon Prof.	Hit Dice (d6)
1	0										1
2	1,250			+30	+15						2
3	2,500			+30	+15						3
4	5,000			+30	+15						4
5	10,000			+30	+15						5
6	20,000			+30	+15						6
7	40,000			+30	+15						7
8	70,000			+30	+15						8
9	110,000			+30	+15						9
10	160,000			+30	+15						10
11	220,000			+30	+15						10+2
12	440,000			+30	+15						10+4
13	660,000			+30	+15						10+6
14	880,000			+30	+15						10+8
15	1,100,000			+30	+15						10+10
16	1,320,000			+30	+15						10+12
17	1,540,000			+30	+15						10+14
18	1,760,000			+30	+15						10+16
19	1,980,000			+30	+15						10+18
20	2,200,000			+30	+15						10+20

Thief and Bard Abilities by Level

Level	Thief's THAC0 and Saving-Throw Table																			
	1	2	3	4	5	6	7	8	9	10	11	12	13	14	15	16	17	18	19	20
THAC0	20	20	19	19	18	18	17	17	16	16	15	15	14	14	13	13	12	12	11	11
Poison, Paralyzation, Death Magic	13	13	13	13	12	12	12	12	11	11	11	11	10	10	10	10	6	6	6	6
Rod, Staff, Wand	14	14	14	14	12	12	12	12	10	10	10	10	8	8	8	8	6	6	6	6
Petrification, Polymorph*	12	12	12	12	11	11	11	11	10	10	10	10	6	6	6	6	8	8	8	8
Breath Weapon**	16	16	16	16	15	15	15	15	14	14	14	14	13	13	13	13	12	12	12	12
Spell***	15	15	15	15	13	13	13	13	11	11	11	11	9	9	9	9	7	7	7	7

* Excluding polymorph wand attacks.

** Excluding those that cause petrification or polymorph.

*** Excluding those for which another saving-throw type is specified, such as death, petrification, polymorph, etc.

How to Use the Thief's Screen

This *Thief's Screen* provides convenient access to tables and lists from the ADVANCED DUNGEONS & DRAGONS® game *Player's Handbook*, *Tome of Magic*, *Complete Thief's Handbook*, and *Complete Bard's Handbook*.

The *Thief's Screen* package contains a screen providing attack numbers (THAC0s) and saving throws for wizard characters in one large-print, combined table. The other side of the screen provides an experience table showing the abilities and powers gained with increasing levels. The screen is assembled by inserting the tabs into the slots as shown in the diagram below. The screen can then fold flat by collapsing the bottom panel for transport to and from your AD&D® game.

Also included are four sheets of reference tables and lists, including a complete list of all wizard spells useable by bards in the *Player's Handbook* and *Tome of Magic*. Permission is given to photocopy these sheets for personal use only.

ASSEMBLY AND STORAGE DIAGRAM

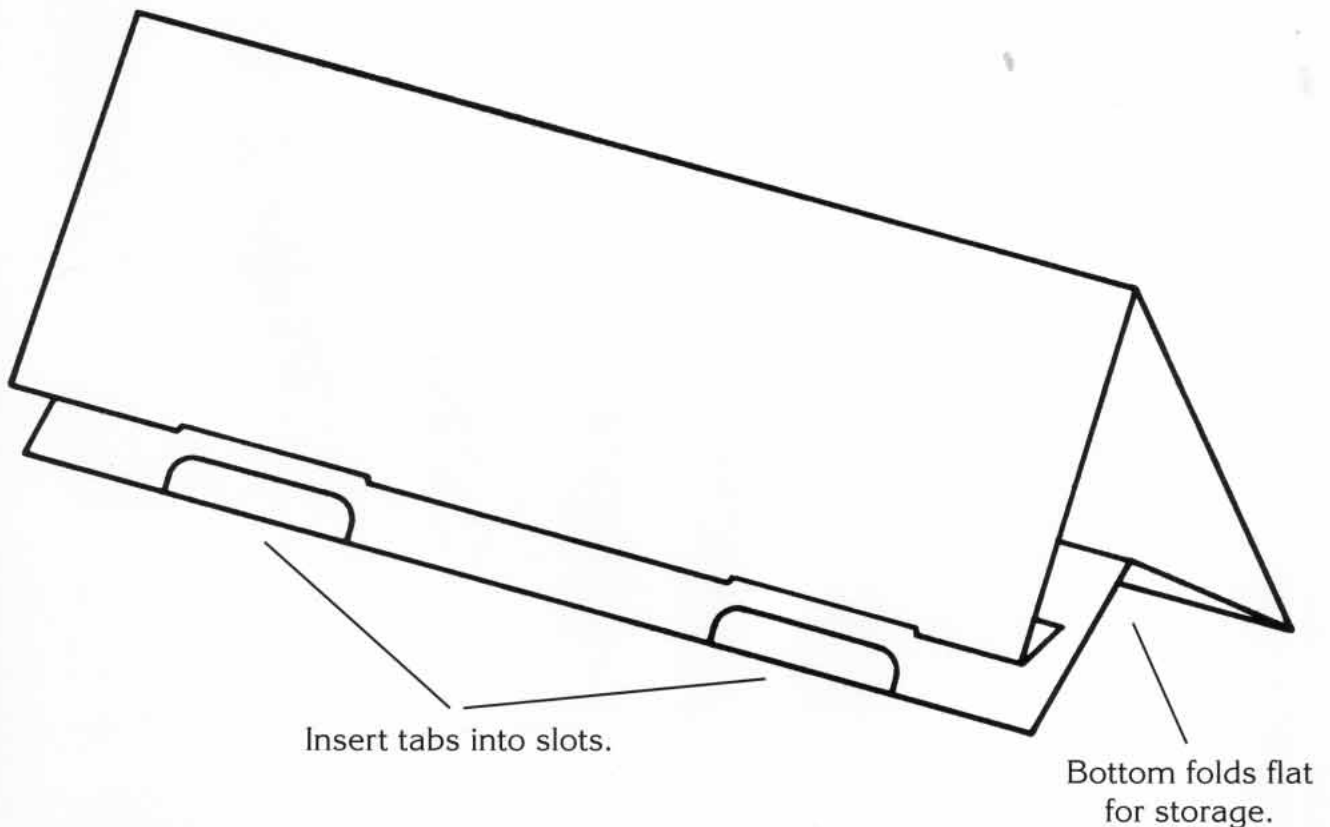



1115XXX4701

©1994 TSR, Inc. All Rights Reserved.



Suitable for All Levels of Play

Thief's Player Pack

You've found the ideal all-in-one playing aid for your favorite game with the AD&D[®] Game *Thief's Player Pack*. Inside your *Player Pack* is the information you need to play your chosen class of character—the thief—with skill and finesse, and a gathering of playing aids selected by TSR game designers as the items both experienced and beginning gamers find most useful. Look at everything you get:

● Multicompartment storage tray and lid

● Game stickers and pencil

● Rugged plastic carrying case

● *Thief's Screen* providing immediate access to the information from the *Player's Handbook* that you use most frequently while playing your character

● Three 25mm lead-free metal player character miniatures—male and female thieves and a bard

● *Thief Character Record Sheets*

● Eight-page booklet of valuable information about role-playing thief characters, includes a miniature painting guide

... Plus, room to carry, store, and organize the AD&D rulebooks and other gaming materials you own!

